

PANS

Property Asset Numbering System



Facilities Management- Planning, Design & Construction
Developed and implemented by
the Office of Space Optimization and
the CAD/GIS and Document Management Office

Appendix A0021.2 to UCB PD&C Standards

TABLE OF CONTENTS

PURPOSE	3
GOALS	3
BUILDING NUMBERING	4
FLOOR NUMBERING	5
ROOM NUMBERING	6
Considerations	6
System Elements	6
1. Floor Designation	7
2. Number Zones	8
3. Rooms Within Rooms	9
2. Wing Identification	9
3. Room Identifiers	11
A. Circulation Areas	11
B. Restrooms	11
C. Shafts	12
D. Structural Areas	12
E. Roofs	12
Master Format Summary	13

PURPOSE

The numbering of buildings, floors, and rooms is an important part of the University's built environment allowing students, faculty, staff and visitors to effectively navigate their way around campus. The numbering system is the framework that creates consistency across campus. Authority for the numbering of buildings, floors, and rooms lies with UCB Planning, Design & Construction. Design teams may use these guidelines to create initial floor and room numbering for a project.

GOALS

The numbering system has been purposefully designed with two goals in mind: standardization and flexibility.

Standardization

A primary goal of the system is to develop a means by which a person will be able to find their way through buildings on campus. These guidelines will also help when numbering buildings, floors, and rooms.

Flexibility

The numbering system is flexible enough to accommodate renovations and additions.

BUILDING NUMBERING

The Boulder real estate portfolio is divided into geographic zones. Once a building number is established it remains permanent and does not change. There may be instances where a name or code change is required. CU policies will be followed for these cases. All property assets will be numbered. Some structures such as sheds, pavilions, etc. may warrant numbering. The 900 series is reserved for infrastructure entities.

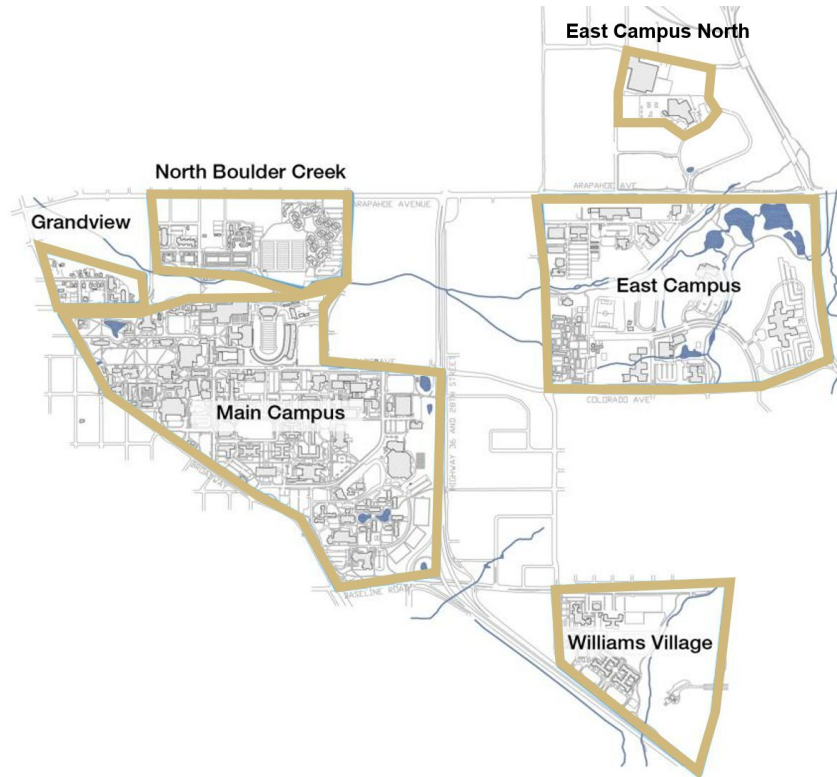

Zone	Number Series
Main Campus	200, 300 & 400
Grandview	200
North of Boulder Creek	100
East Campus	500
East Campus North	500
Williams Village	600

Zone (not shown)	Number Series
South Campus	700
Mountain Research Station	000
Off Campus	800

FLOOR NUMBERING

Floors are numbered as shown below. The building’s primary entrance is generally the first floor.

<i>Floor Name</i>	<i>Floor Code</i>	
Roof*	Roof	
Fifth	05	
Fourth	04	
Third	03	
Second Mezzanine	2M	
Second	02	
First Mezzanine	1M	
First	01	Above Grade
<hr/>		
First Basement	1B	Below Grade
Second Basement Mezzanine	2BM	
Second Basement	2B	
Third Basement	3B	

**NOTE: Roof plans are treated differently. They include all building roofs, regardless of floor.*

ROOM NUMBERING

Considerations

1. Floor identification
2. Main entrance/exit points
3. Potential traffic flow paths
4. General floor configuration
5. Any unique features

System Elements

1. Floor designation
2. Number zones
3. Rooms within rooms
4. Wing identification
5. Room identifiers
 - a. Circulation
 - b. Restrooms
 - c. Shafts
 - d. Structural Areas
 - e. Roofs

1. Floor Designation

Each room number contains a prefix indicating its floor.

<i>Floor Name</i>	<i>Floor Code</i>	<i>Room Prefix</i>	<i>Room Examples</i>	
Roof*	Roof	RF	RF433, RF355	
Third	03	3	333, 355	
Second	02	2	233, 255	
First Mezzanine	1M	1M	1M33, 1M55	
First	01	1	133, 155	Above Grade
First Basement	1B	1B	1B33, 1B55	Below Grade
Second Basement Mezzanine	2BM	2BM	2BM33, 2BM55	
Second Basement	2B	2B	2B33, 2B55	

**NOTE: Roof plans are treated differently. They include all building roofs, regardless of floor. Roof spaces receive a number based on the highest floor crossed and are prefixed with "RF".*

2. Number Zones

Floors should be subdivided into groupings of tens to create room number zones. These zones form the general structure. Which zone a room falls within is defined by the placement of the primary entrance. Use this strategy to provide sufficient capacity to add additional rooms. Use even numbers on one side of the corridor and use odd numbers on the other.

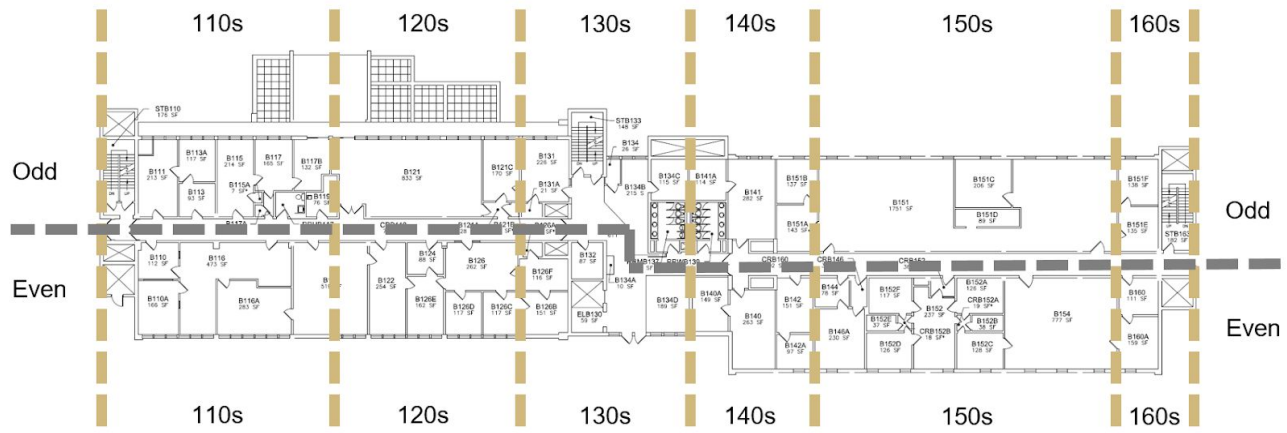

Example 1

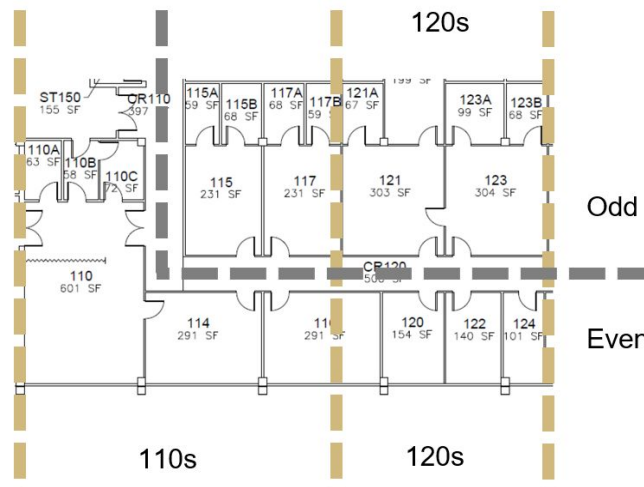

Example 2

3. Rooms Within Rooms

Rooms within rooms are spaces accessed through a primary or entrance space. These spaces are identified with an alpha-character* suffix. Multiple rooms shall be lettered sequentially starting left-of-entrance moving in a clockwise direction.

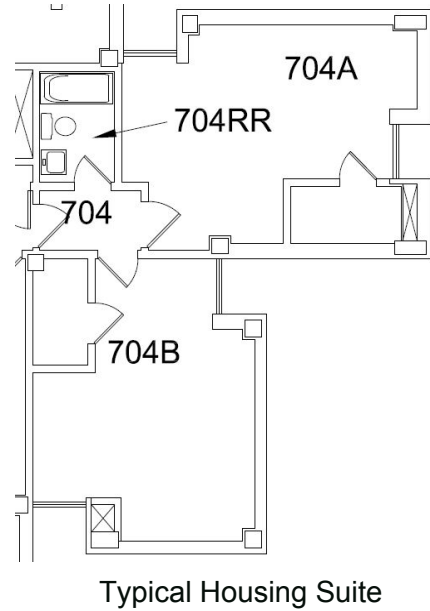
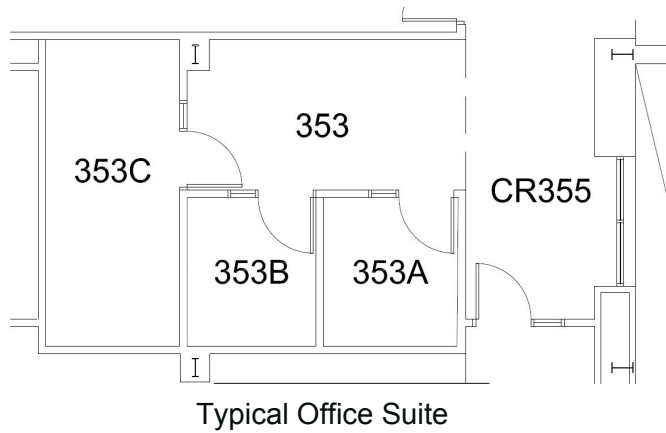

**NOTE: Certain letters should not be included in suffixes to avoid confusion with numbers, such as: I, O, and Q.*

2. Wing Identification

Wing identification may be necessary in large buildings or to accommodate an addition. An alpha-character prefix is added to each room number within the wing.

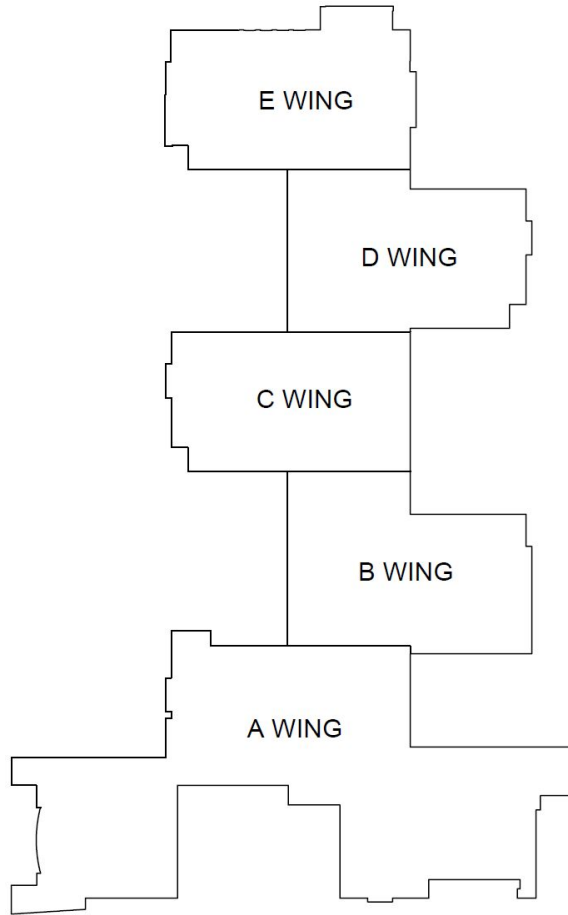

Example 1

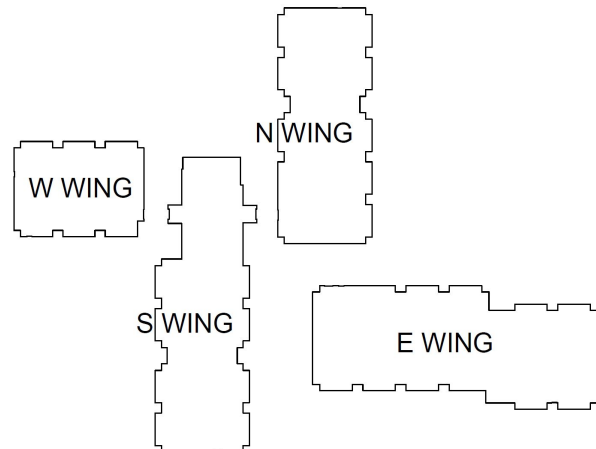

Example 2

<i>Wing</i>	<i>Room Prefix</i>	<i>Room Examples</i>
North	N	N 133, N 155A, CRN 130, RRMN 125
West	W	W 233, W 255A, CRW 250, RRWW 225
A	A	A 312, A 354A, CRA 395, RRUA 360
B	B	B 415, B 423B, CRB 468, RRMB 433

3. Room Identifiers

Room identifiers exist to identify service rooms and spaces. Several of these space types are described below; a) circulation, b) restrooms, c) shafts, d) structural areas, and e) roofs.

A. Circulation Areas

Rooms such as public corridors, stairs, and elevators are considered to be circulation areas. Room numbers for these spaces should be vertically stacked within a building.

<i>Circulation Area</i>	<i>Room Prefix</i>	<i>Room Examples</i>
Corridor	CR	CR130, CR230
Stairwell	ST	ST130, ST230
Elevator	EL	ELIB30, ELI30
Loading Dock	LD	LD130, LDW1B30

B. Restrooms

Each type of restroom receives a unique prefix.

<i>Restroom Type</i>	<i>Restroom Prefix</i>	<i>Room Examples</i>
Men's	RRM	RRM133, RRM155
Women's	RRW	RRW233, RRW255
Unspecified	RRU	RRU1B33, RRU1B55

Residence hall restrooms are treated differently. Resident-only restrooms entered from a corridor receive a room identifier prefix. Dorm suite restrooms receive a room identifier suffix.

<i>Residence Hall Restroom Type</i>	<i>Restroom Prefix</i>	<i>Restroom Suffix</i>	<i>Room Examples</i>
Unspecified Restrooms	RR	-	RR325, RR467
Dorm Suite Restroom	-	RR	349RR, 462RR

C. Shafts

Ventilation shafts, as defined by the Postsecondary Education Facilities Inventory and Classification Manual (FICM), should receive a “Y” prefix. No signage necessary for these types of spaces. Numbers for these spaces should be vertically stacked within a building. These spaces can be numbered sequentially rather than related to nearby room numbers.

<i>Floor</i>	<i>Shaft Room Prefix</i>	<i>Room Examples</i>
Fourth	Y	Y401
Third	Y	Y301
Second	Y	Y201

D. Structural Areas

Structural areas receive a “Z” prefix. These space numbers are used for tracking data only. Examples include a) unexcavated spaces, b) all spaces with $\leq 3'$ vertical space, c) exterior spaces as needed. No signage necessary for these types of spaces.

E. Roofs

Roof areas receive an 'RF' prefix and are numbered according to the highest floor crossed. Roof plans include all building roofs, regardless of floor. See plan, section, and chart below. Open air spaces (with building below), such as mechanical spaces, terraces, etc. should receive a roof prefix and number.

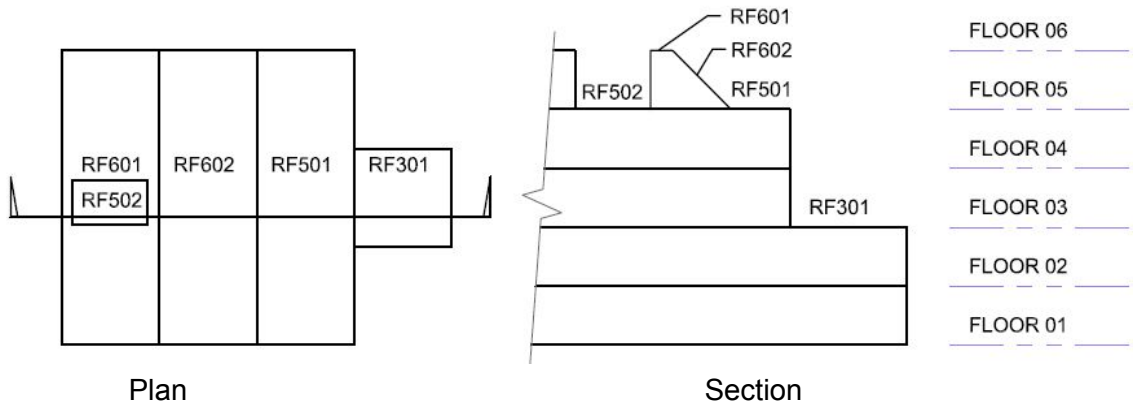

<i>Roof Crossed</i>	<i>Roof Prefix</i>	<i>Room Examples</i>
Sixth	RF	RF655
Third	RF	RF378

Master Format Summary

Master format summary featuring room number components and examples.

<i>Room Identifier +</i>	<i>Wing +</i>	<i>Floor +</i>	<i>Room Number =</i>	<i>Result</i>
-	-	2	65	265
-	A	1B	87	A1B87
CR	N	1	55	CRN155
RRU	-	3	76	RRU376
Y	-	4	07	Y407
Z	-	5	01	Z501
RF	W	6	05	RFW605