

Section D7050

IT System Testing & Labeling

D7050 – Subsections:

- D7050: Introduction
- D7050.11: UCB Requirements - Materials
- D7050.2: UCB Requirements – Execution
- Appendices

D7050 - Introduction

This section outlines standards and requirements for IT system testing & labeling in all campus projects.

D7050.11 – Testing and Labeling – Materials

1. Refer to Appendix **D7050.111** for IT System Testing & Labeling Materials.
2. D7050.112 - COPPER UTP CABLE TESTERS
 - a. Test equipment and field test instruments shall meet current applicable ANSI/TIA requirements.
 - b. Physical interface shall be modular RJ-45 connector and a serial port with DB-9 connector.
 - c. Store test results including date stamp of tests and UCB OIT jack designator for each tested link.
 - d. Provide standard test reports in pdf format with both summary and individual test results for tested cables.
 - e. Have auto-testing to determine if cable meets requirements of ANSI/TIA standards for 10Base-T, Fast Ethernet, Gigabit Ethernet, and 10 Gigabit Ethernet.
3. D7050.113 - OPTICAL FIBER CABLE TESTERS
 - a. Field test instruments shall be within the calibration period recommended by the manufacturer.
 - b. Field test instruments for multimode fiber cabling shall meet the requirements of ANSI/TIA/EIAA-526-14.
 - c. Field test instruments for singlemode fiber cabling shall meet the requirements of ANSI/TIA/EIA-526-7.
 - d. Optical Loss Test Set (OLTS) Multimode Fiber Light Source
 - i. Provide dual stabilized LED light sources with central wavelengths of 850 nm (± 30 nm) and 1300 nm (± 20 nm).
 - ii. Output power of -20 dBm minimum.
 - iii. The light source shall meet the launch requirements of ANSI/TIA 526-14-B including Encircled Flux.
 - iv. Spectral width of sources shall be ≤ 50 nm of 850 nm wavelengths and ≤ 140 nm for 1300 nm wavelengths.
 - v. Output stability +/- 0.40 dB from 0 to 50 degrees C.
 - vi. Long term output stability +/- 0.10 dB at 25 degrees C.
 - vii. Connector types shall include: ST, SC, and LC
 - e. OLTS Singlemode Fiber Light Source
 - i. Provide dual stabilized laser light sources with central wavelengths of 1310 nm (± 20 nm) and 1550 nm (± 20 nm).
 - ii. Output power of -10 dBm minimum.
 - iii. Output stability +/- 0.40 dB from 0 to 50 degrees C.

- iv. Long term output stability +/- 0.10 dB at 25 degrees C.
 - v. Connector types shall be ST, LC, LC-APC, and SC-APC.
 - f. OLTS Power Meter
 - i. Provide 850 nm, 1300/1310 nm, and 1550 nm selectable wavelength test capability.
 - ii. Power measurement uncertainty of ± 0.25 dB.
 - iii. Store reference power measurement.
 - iv. PC interface (serial or USB).
 - v. Connector types shall include: ST, SC, LC, LC-APC, and SC-APC.
 - g. Optical Time Domain Reflectometer (OTDR)
 - i. Selectable Cable Index of Refraction
 - ii. Visual fault locator for continuity checks and dead zone fault location
 - iii. Equipped with launch jumper cable of sufficient length to offset entry "dead zone"
 - iv. Multimode requirements:
 - 1. Dual selectable wavelengths of 850 nm (± 20 nm) and 1300 nm (± 20 nm).
 - 2. Event dead zones of 3.7 m maximum at 850 nm and 1300 nm.
 - 3. Attenuation dead zones of 10 m maximum at 850 nm and 13 m maximum at 1300 nm.
 - 4. Distance range not less than 2000 m.
 - 5. Dynamic range at least 10 dB at 850 nm and 1300 nm.
 - v. Singlemode Requirements:
 - 1. Dual selectable wavelengths of 1310 nm (± 20 nm) and 1550 nm (± 20 nm).
 - 2. Event dead zones of 3.5 m maximum at 1310 nm and 1550 nm.
 - 3. Attenuation dead zones of 10 m maximum at 1310 nm and 12 m maximum at 1550 nm.
 - 4. Distance range not less than 10000 m.
 - 5. Dynamic range at least 10 dB at 1310 nm and 1550 nm.
 - vi. Connector types shall include: ST, SC, LC, LC-APC, and SC-APC.
 - h. Fiber Microscope
 - i. Magnification of 200X or 400X for end face inspection.
 - ii. May be combined into one instrument with the OTDR.
 - 4. D7050.11 – LABELS
 - a. Faceplate labels shall be printed and supplied by the Contractor with an electronic label maker.
 - b. All jacks in new patch panels shall be labeled using labeling software and labels available from the patch panel manufacturer.
 - c. The one page Copper Termination Sheet and Fiber Termination Labels will be provided and installed by UCB OIT. All additional labels needed shall be supplied and installed by the Contractor.
 - d. Labels for cable marking: vinyl substrate with a white printing area and a clear "tail" that self laminates the printed area when wrapped around the cable. If cable jacket is white, provide cable label with printing area that is any other color than white, preferably orange or yellow - so that the labels are easily distinguishable.
 - e. Pre-printed labels shall meet legibility, defacement, exposure and adhesion requirements of UL 969.
 - f. Hand written labels are not allowed.
 - g. Cable ID tags shall be provided and installed by the Contractor on all OSP backbone cables.

D7050.12 – Testing and Labeling – Execution

- 1. D7050.121 - CABLE TESTING
 - a. Final testing shall be scheduled and conducted in the presence of the UCB OIT representative as specified in Section **D7040**.

- b. All outlets, cables, patch panels and associated components shall be fully assembled and labeled prior to field-testing. Any testing performed on incomplete systems shall be redone on completion of the work.
 - c. Complete and submit electronic test results for all UTP copper and fiber optic cabling prior to scheduling the final testing with OIT.
 - d. Testing for UTP copper and fiber optic cabling shall be performed on each cabling segment (connector to connector).
 - e. Any link that fails testing shall be diagnosed and corrected. Any corrective action that must take place shall be documented and followed with a new test to prove that the corrected link meets performance requirements. The final and passing result of the tests for all links shall be provided in the test results documentation.
2. D7050.122 - COPPER UTP CABLE TESTING
- a. Test 100% of installed backbone copper cabling for:
 - i. Wire Map
 - ii. Length
 - b. Perform the following Permanent Link tests for 100% of installed copper horizontal cabling as described in applicable ANSI/TIA-568 standards:
 - i. Wire Map
 - ii. Length
 - iii. Insertion Loss
 - iv. Pair-To-Pair NEXT Loss
 - v. Propagation Delay
 - vi. Delay Skew
 - c. Perform the following Permanent Link tests for 100% of installed Category 6, and Category 6A horizontal copper cabling as described in applicable ANSI/TIA-568 standards:
 - i. PSNEXT Loss
 - ii. Pair-To-Pair ELFEXT
 - iii. PSELFEXT
 - iv. Return Loss
 - d. Cross-connects from horizontal to backbone cabling will not be in place for these tests.
 - e. The wire map test shall verify pair to pin termination at each end and check for connectivity errors. The wire map shall indicate the following for each of the eight conductors:
 - i. Continuity to the remote end
 - ii. Shorts between any two or more conductors
 - iii. Reversed pairs
 - iv. Split pairs
 - v. Transposed pairs
 - vi. Any other miswiring
 - f. The maximum length of the permanent link for horizontal cable shall be 90 meters. Shorten any cable runs as required at no additional cost to UCB.
 - g. Replace and or repair cable and terminations as necessary to assure 100% passing performance specifications.
 - h. Submit electronic test reports in standard pdf format for each copper cabling permanent link to UCB OIT before project is closed.
3. D7050.123 - OPTICAL FIBER CABLE TESTING
- a. Testing shall be performed using high-quality test cords of the same fiber type as the cabling under test.
 - b. Perform link attenuation (OLTS) testing of all installed multimode fiber optic strands after splicing and termination in accordance with current ANSI/TIA standards.

- i. One direction with an optical light source and an optical power meter.
- ii. Test at two wavelengths to account for attenuation differences due to wavelength:
 1. 850 nm and 1300 nm for multimode strands
 2. 1310 nm and 1550 nm for singlemode strands
- iii. Test multimode strands in accordance with TIA-526-14, One Reference Jumper with Encircled Flux.
- iv. Test Singlemode strands in accordance with TIA-526-7, One Reference Jumper.
- v. Test cords for link attenuation testing shall be between 1 m and 5m in length.
- vi. The total attenuation budget for each fiber cable length (end-to-end) shall be calculated by the following formula:
 1. Link Attenuation (dB) = Cable_Attn (dB) + Connector_Attn (dB) + Splice_Attn (dB)
 2. Cable_Attn (dB) = Attenuation_Coefficient (dB/km) * Length (Km)
 3. Connector_Attn (dB) = number_of_connector_pairs * connector_loss (dB)
 4. Maximum allowable connector_loss on multimode fiber = 0.5 dB
 5. Maximum allowable connector_loss on singlemode fiber = 0.3 dB
 6. Splice_Attn (dB) = number_of_splices * splice_loss (dB)
 7. Maximum allowable splice_loss on multimode fiber = 0.3 dB
 8. Maximum allowable splice_loss on singlemode fiber = 0.2 dB
 9. The values for the Attenuation_Coefficient (dB/km) are listed in the table below:

Type of Optical Fiber	Wavelength (nm)	Attenuation coefficient (dB/km)	Wavelength (nm)	Attenuation coefficient (dB/km)
Multimode 62.5/125 μm	850	3.5	1300	1.5
Multimode 50/125 μm	850	3.5	1300	1.5
Single-mode (Inside plant)	1310	1.0	1550	1.0
Single-mode (Outside plant)	1310	0.5	1550	0.5

- c. Polarity Testing:
 - i. Paired duplex fibers in multi-fiber cables shall be tested with an OLTS to verify polarity.
- d. Test all installed fiber optic strands after splicing and termination with an OTDR per ANSI/TIA standards:
 - i. End-to-end bi-directional signature trace with fault finding, connection point reflections, fiber bend, pressure point locations, etc. (test results must be turned in for both ends of each strand).
 - ii. One wavelength, 1300 nm for multimode strands.
 - iii. One wavelength, 1550 nm for singlemode strands.
 - iv. The launch cable installed between the OTDR and the first link connection shall be approximately 100 m in length.
 - v. The receive cable installed after the last link connection shall be at least 25 m in length.
 - vi. Multimode fiber connector losses shall be ≤ 0.5 dB at 1300 nm
 - vii. Singlemode fiber connector losses shall be ≤ 0.3 dB at 1550 nm
 - viii. Multimode fiber splice losses ≤ 0.3 dB at 1300 nm
 - ix. Singlemode fiber splice losses ≤ 0.2 dB at 1550 nm

- x. Localized attenuation shall not exceed 0.5 dB at any point
 - e. Magnified End face Inspection:
 - i. Fibers may be inspected at 250X or 400X magnification for end face quality. 250X magnification is suitable for inspecting multimode and singlemode fibers. 400X magnification may be used for detailed examination of singlemode fibers.
 - ii. Scratched, pitted, or dirty connectors shall be diagnosed and corrected.
 - f. Fibers that are broken or damaged shall be replaced at no cost to UCB and replaced fiber optic cables shall be re-tested.
 - g. Submit electronic OTDR test results reports for each fiber optic cable strand to UCB OIT before project is closed.
4. D7050.124 - CABLE IDENTIFICATION AND LABELING:
- a. Neatly and permanently label all copper and fiber optic backbone cables with the cable number at both ends.
 - b. The UCB standard outlet numbering plan to be used for labeling faceplates, 66-blocks, patch panels, and fiber terminations is described in the attached document **Labeling and Testing**.
 - i. Refer to Appendix **D7050.1241** for Labeling and Testing document.
 - c. Fiber schematics for termination of backbone and horizontal fiber strands in the fiber enclosures will be provided by UCB OIT. Fiber cables shall be labeled following the numbering shown on the fiber schematics.
 - d. The identification and labeling for all copper and fiber optic cables and TR/ER terminations shall be clearly labeled and approved by UCB OIT prior to scheduling final testing with OIT.
 - e. The "FIBER OPTIC CABLE" tags must be used in the ER, TR, tunnels, and manholes, on both sides of all fiber coils and every 8 feet of additional exposed fiber cable.

Appendices

D7050.111 - IT System Testing & Labeling Materials.

Pre-Approved Equipment Schedule

Line	Description	Manufacturer	Part Number
1	Cable ID tags	Nelco	IDNY-1500
2	Fiber Cable tags	Panduit	PST-FO

D7050.1241 - Labeling and Testing document.

Labeling and Testing

Base: This section is an introduction to the numbering of work-area outlets at the UCB (University of Colorado at Boulder). Although UCB numbers the work-area outlets in the database and expects this on the “T5,” not all information is always applied (i.e. on work-area outlet). The numbering for each work-area outlet shall include:

- 1) Communication room number (ER or TR)
- 2) Rack & panel number, or block number, for the station cable in the A position.
- 3) Position on the panel or block for the station cable in the A position
- 4) Jack position in faceplate – letters A through F for each station cable
- 5) Cable Type for each Jack:
 - a. C6 or 6 = category 6
 - b. 6A= Augmented category 6
 - c. M6 = multimode 62.5/125 micron.
 - d. S = singlemode
- 6) Rack & panel number or block number for each station cable.
- 7) Position on panel or block for each station cable
- 8) Ownership information for specific types of outlets when applicable

See Attachment #1 for sample.

Note: This sample has legacy numbering for category 5E and TV which will only be found on existing cabling and not to be run as new without written approval.

Work-Area Outlet: The work-area outlet number on the top of the faceplate will include:

- 1) Ownership information for specific types of outlets when applicable
- 2) Communication room number (ER or TR)

- 3) Rack & panel number, or block number, for the station cable in the A position.
- 4) Position on the panel or block for the station cable in the A position

The work-area outlet number on the faceplate is based on where the cable for the jack in the A position terminates. This is the only number on the work-area outlet faceplate (e.g., 135 – 1D – 8 or 135 – 1 – 8).

See Attachment #2 for sample.

Notes: *Use Dymo Electronic Labelmanager (or equivalent) to print labels.

*Hand-written labels are not allowed.

66 Block: The 66 blocks have the following labeling:

Used in Main Location with category 3 riser and in TR (Telecommunications Room) for category 3 riser on patch panels.

- 1) All riser cable will have the riser count on the block for the correct cable pair number, starting with the first pair number and every fourth pair (i.e. 1, 5, 9, 13, 17, and 21). Count will start on the top left working down towards the bottom and then to the right side of the first block and down towards the bottom of each row.

See Attachment #3 for sample.

Patch Panel: All patch panels will be labeled on the left side with a letter that designates the panel's position in the rack.

Used in the MDF and IDF TR for Riser cabling to the patch panel

Patch panel Riser will be terminated 1 pair per port with the 25th pair of each binder group terminated with port 24 so port 24 has two pair (ie port 24 will have pair 24 and 25). The labeling will follow the 66 block numbering in the MDF room except every pair will be numbered not every fourth. The contractor shall use the Patch Panel Riser numbering excel sheet from OIT to guide them in the numbering.

- 1) The MDF shall have a tie cable from the 66 block field to the relay rack and the numbering shall follow the 66 block and patch panel for example 1, 2, 3, 4, 5, 6, 7, etc. with pair 25 terminated on the 24th port.

See Attachment #4 for sample.

Used in IDF TR for Work Area cabling

Patch panel jacks will be labeled using the same number that is on the work-area outlet faceplate (without the communication room number), followed by the jack association letter. Each jack on the patch panel will be labeled with:

- 1) Rack & panel number, or block number, for the station cable in the A position on the associated work-area outlet faceplate
- 2) Position on the panel or block for the station cable in the A position on the associated work-area outlet faceplate
- 3) Jack position in the associated work-area outlet faceplate for each station cable – letters A through F
- 4) The “RM” with the room number that the work-area outlet is located in

See Attachment #5 for sample.

- Notes:**
- * All jacks in new patch panels shall be labeled using labeling software and labels available from the patch panel manufacturer.
 - * Use Dymo Electronic Label-maker (or equivalent) to print labels for jacks and riser in existing and new patch panels.
 - * Hand-written labels are not allowed.

Krone Block: Krone blocks will be numbered and terminated left to right per block and left to right per rack. The numbering is similar to the patch panel layout.

8 Pair Ultim8 Blocks

- 1) Each block is labeled with the block number and the Riser ID with the pair count on the top label of the 8 pair Ultim8 blocks.
- 2) Label each 8 pair Ultim8 block on the front of the top row, as follows:

- a) Rack & panel number, or block number, for the station cable in the A position on the associated work-area outlet faceplate
- b) Position on the panel or block for the station cable in the A position on the associated work-area outlet faceplate
- c) Jack position in the associated work-area outlet faceplate for each station cable – letters A through F
- d) “RM” with the room number that the work-area outlet is located in.

300-Pair 4-Pair Color Coded Kit - ****NOTE these were used for riser and are no longer in OIT standards, this is for reference only****

- 1) The cable ID and pair count is listed for each pair.

See Attachment #6 for sample.

(All labels for Krone sold separately!)

110 Block: ****NOTE 110 Blocks were used for past projects and are no longer in the OIT standards, this is for reference only.**

- 1) Jack ID numbering is similar to the patch panel
 - a) Each station cable will have all 4 pairs terminated and will be labeled Block #, Position # 1-6 per row and up to 24 per block, and room # jack is in the “A” position.
 - b) If a cable is added to an existing outlet, the cable ID in the TR will need to reflect the faceplate “A” position and faceplate position being added. Example: 1-1B, 1-1C, 1-1D, 1-1E or 1-1F.
- 2) Riser or tie cable will be labeled every 5th pair and marking the first pair of each 25-pair group.

See Attachment #7 for sample.

- 3) When 110 hardware is used, jacks are not dedicated to a riser count. A cross connect is necessary to connect from a riser pair to a jack.

Jack Position Sheets (T-5): T-5 Jack position sheets shall be provided for all projects as specified in Section **D7040.13**. The Jack Position sheet shall need to include CAD numbers and

room numbers from the floorplan drawings and all fields of data for each work-area outlet and station cable as described in this document.

See *UCB OIT Telecom CAD Standards Guideline*, attached to Section **D7060**, for sample.

Protectors: The cable count and pairs shall be labeled on each protector (i.e. 11, 1 – 100 broken out for each protector).

Riser Copper Sheet: UCB will provide a master list with riser pair counts to be assigned in the MAIN and each TR. All riser pairs will be terminated and labeled according to the Riser Copper Sheet provided by UCB.

Backbone Cables: All exposed backbone cables shall be clearly labeled with cable type, cable ID, and pair/strand count before and after every splice, when leaving or entering the building and in communication rooms, tunnels, and all man holes or hand holes.

Prior to Test, Check List

1. For all new fiber installs:
 - a. Fiber labels
 - b. Numbers on Fiber panels
 - c. Racks, shelves and panels properly lettered
 - d. Coils permanently mounted
 - e. Floor cleaned-up and trash emptied

2. Testing day:
 - a. Keys for terminals
 - b. Communication devices for testing purposes
 - c. Working test equipment
 - d. Two knowledgeable testers & OIT Rep.

Note: If all above mentioned items are not completed, you are not ready to test.

Check List (Fiber)

1. For all fiber upgrades and installs:
 - a. Place all labels in terminals affected
 - b. Label racks, shelves and patch panels correctly
 - c. Place cable tags as specified in this document
 - d. Place numbers to the left on the Fiber panels
 - e. Place coupler grooves to the top when installing
 - f. Mount fiber coils permanently per print
 - g. Clean terminal and empty trash
2. Test Day Bring:
 - a. Keys for the terminals
 - b. Communication devises for testing purposes
 - c. Working test equipment
 - d. Two knowledgeable testers and an OIT Rep will meet you at the location

NOTE: If all the above-mentioned items are not completed,
you are not ready to test!

Check List (Copper)

1. For all copper upgrades and installs:
 - a. Place all new copper sheets in terminals affected
 - b. Label racks, shelves and patch panels correctly
 - c. Place clear plastic covers on all 66 blocks
 - d. 66 blocks and Patch Panels numbered correctly
 - e. Clean terminal and empty trash
 - f. Pre-test completed?

2. Test Day Bring:
 - a. Keys for the terminals
 - b. Floorplans
 - c. Updated T-5 Jack Position Sheets
 - d. Communication devices for testing purposes
 - e. Working test equipment
 - f. Two knowledgeable testers and an OIT Rep will meet you at the location

**NOTE: If all the above-mentioned items are not completed,
you are not ready to test!**

SECTION D

October 1, 2021

JACK NUMBERING PLAN

ALL

OUTLET #	DATABASE INFORMATION ONLY
*135-1D-8A5E	
*135-1D-8B6	-1D-16
*135-1D-8CTV	-1tv-1
*135-1D-8D6A-1E	-2
*135-1D-8EM5-1C	-22
*135-1D-8FS	-1C-23

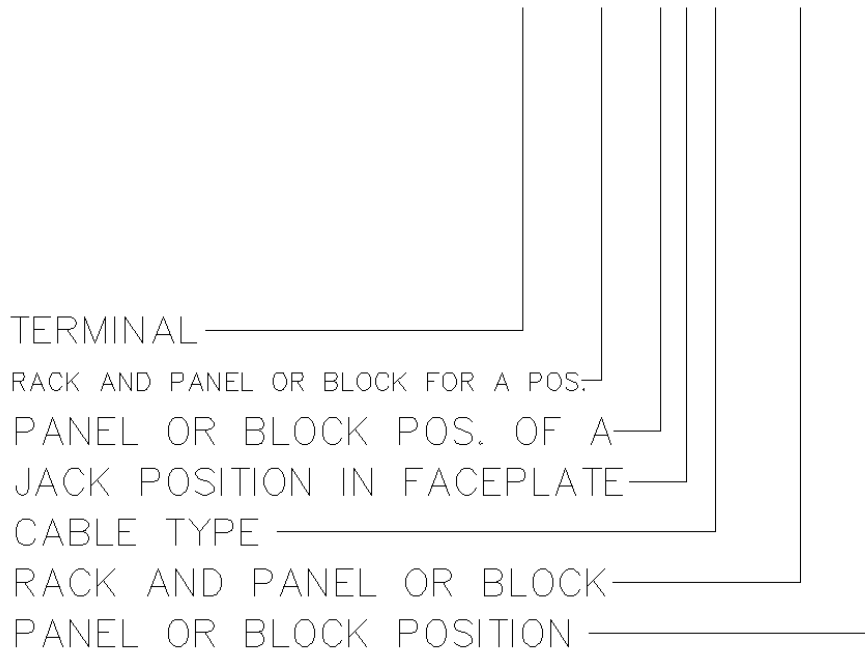

* OWNERSHIP INFORMATION – THE LABELING OF FACEPLATES FOR ALLIANCE NETWORK AND QWEST/CENTURYLINK JACKS SHALL INCLUDE THE FOLLOWING PREFIXES BEFORE THE CLOSET NUMBER ON THE OUTLET:

AN = ALLIANCE NETWORK
 QW = QWEST/CENTURYLINK

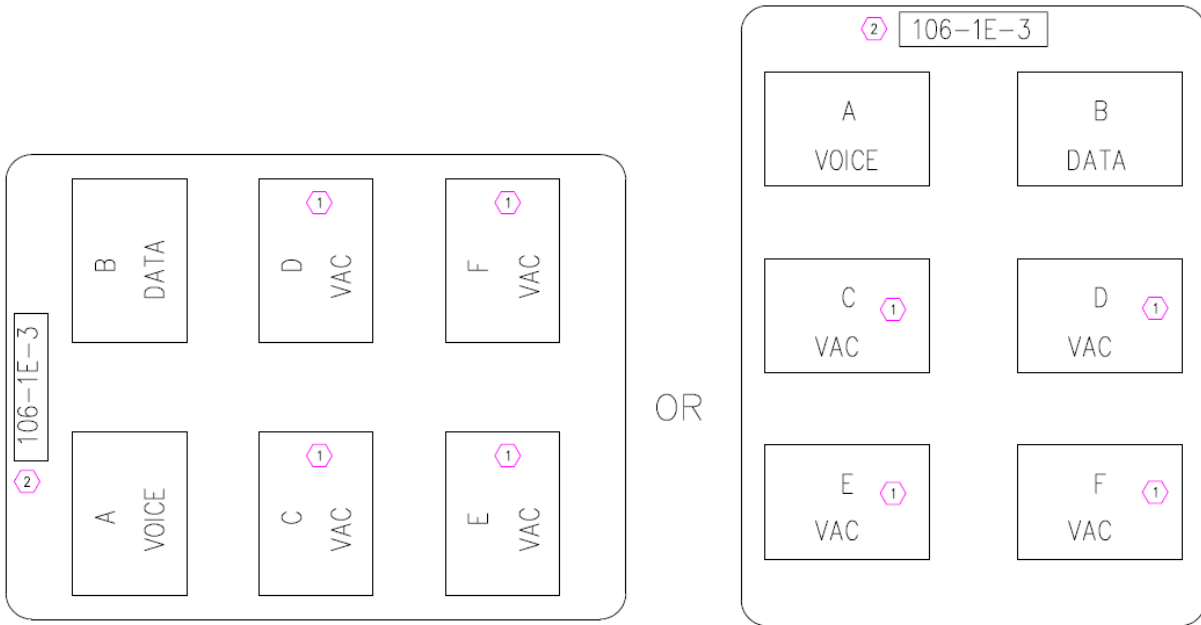

COMMUNICATION FACEPLATE

NOT TO SCALE

COMMUNICATION FACEPLATE NOTES

- 1 USE DUST COVERS FOR ALL UNPOPULATED SLOTS. FOLLOW UCB JACK NUMBERING PER OIT STANDARDS.
- 2 FACEPLATE LABEL EXAMPLE: 106-1E-3. THE FACEPLATE LABEL MUST MATCH THE "A" POSITION OF THE FACEPLATE. ALL OTHER CABLES ARE LABELED ON THE PATCH PANEL SIDE WITH THE LETTER POSITION IT TERMINATES IN ON THE FACEPLATE (SEE PATCH PANEL LABELING)

ATTACHMENT #2

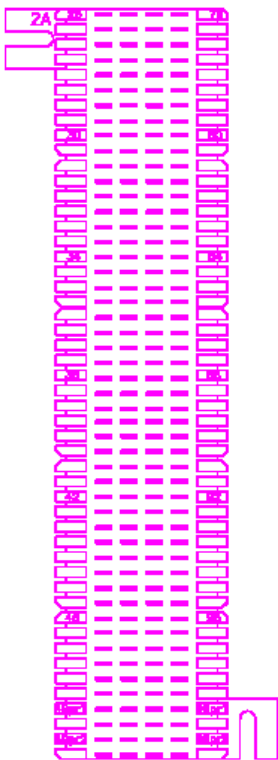
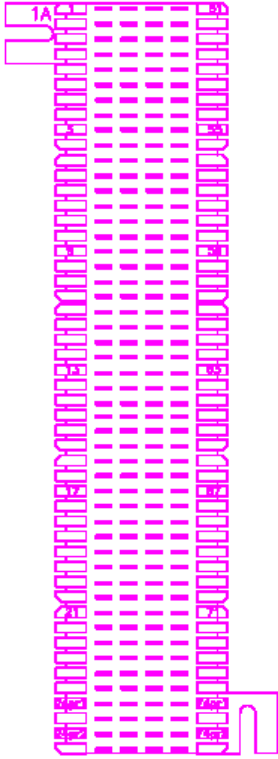

Attachment #3

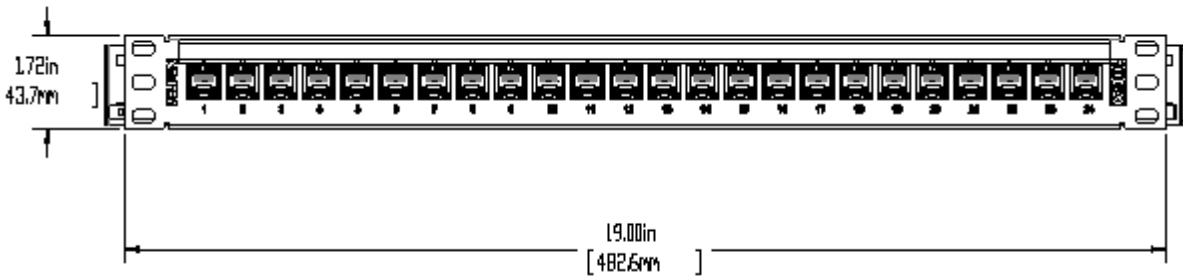

Attachment #4

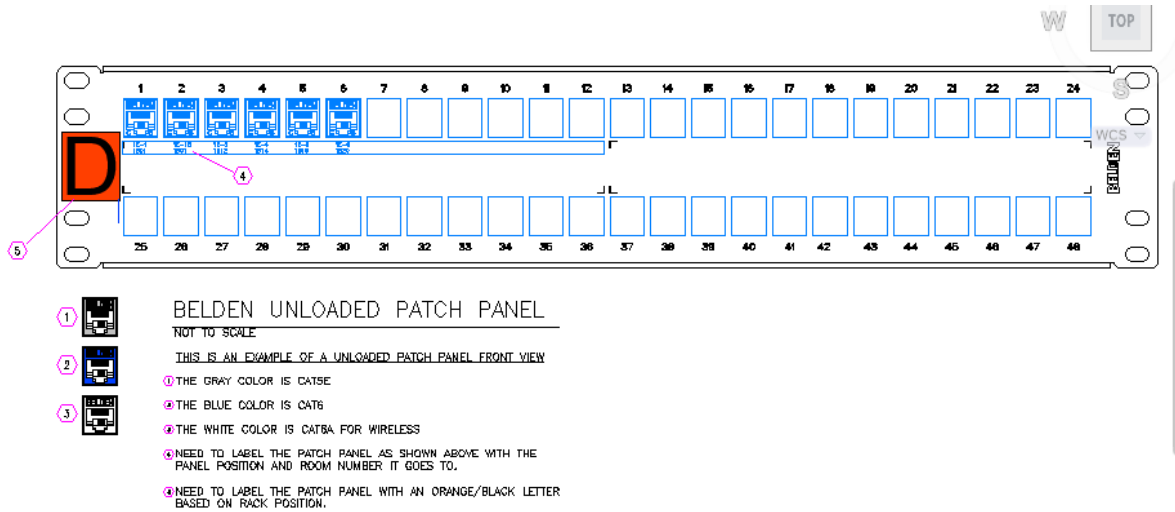

Attachment #5

SECTION D

October 1, 2021

KRONE

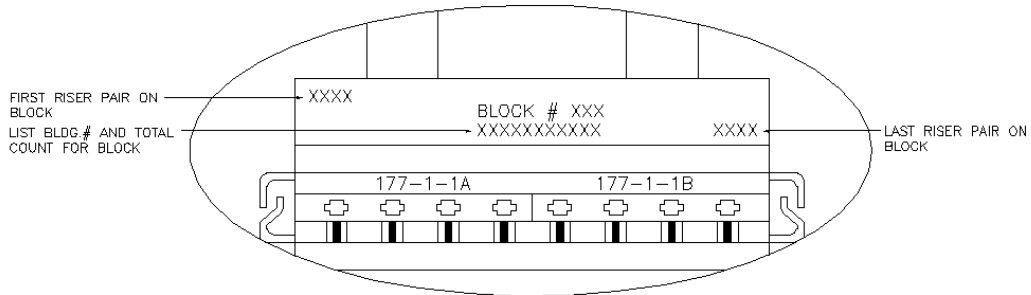

1	2	3
96-PAIR	96-PAIR	96-PAIR
UMS	UMS	UMS
KRONE#	KRONE#	KRONE#
6636-1	6636-1	6636-1
596-06	596-06	596-06

8 PAIR ULTIM8 BLOCKS

NOT TO SCALE

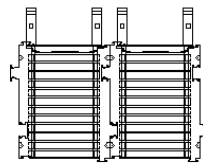

300 PAIR 4 PAIR COLOR CODED KIT

NOT TO SCALE

SECTION D

October 1, 2021

110 BLOCK JACK LABELING EXAMPLE.

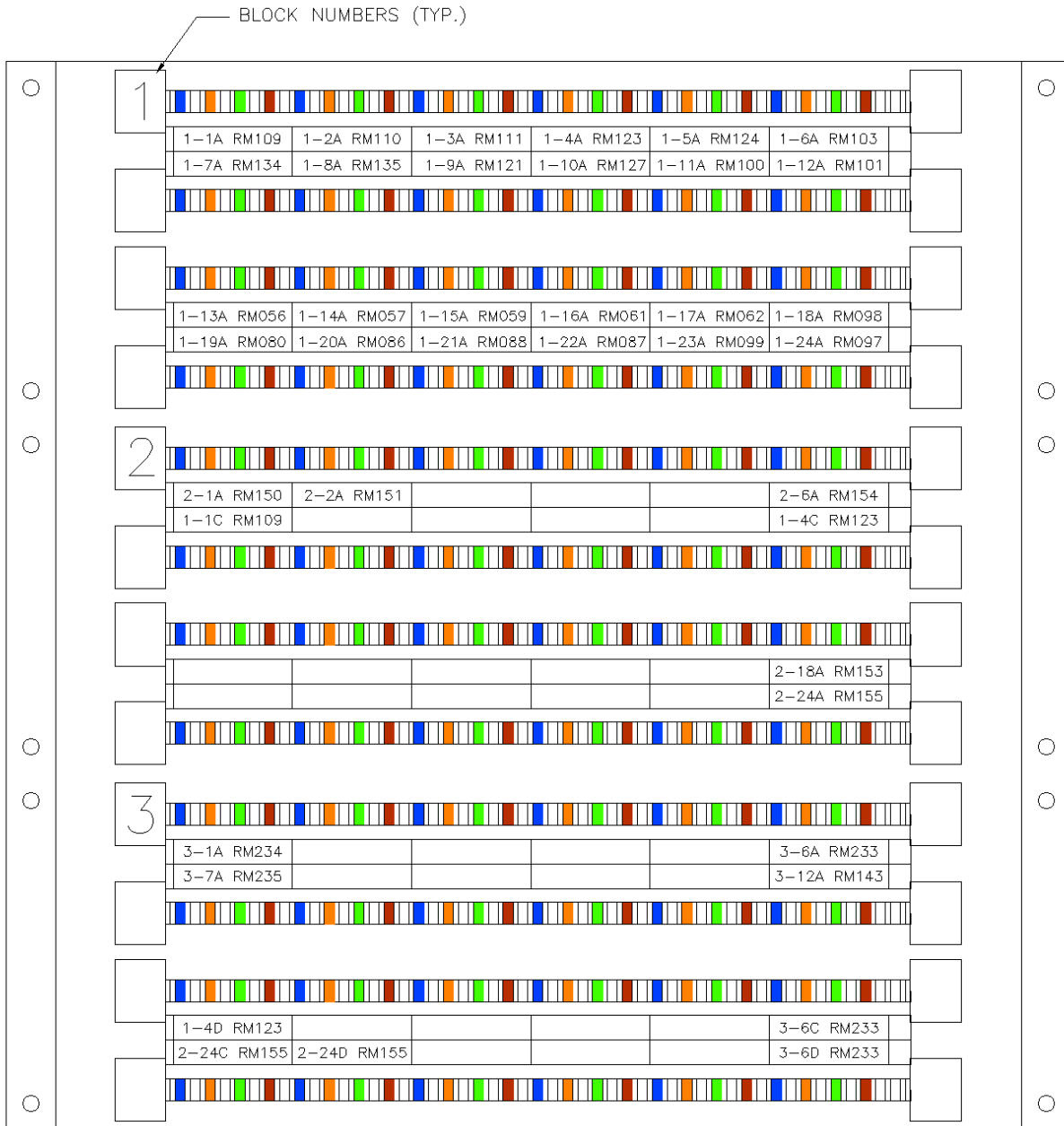

ATTACHMENT #7
110 BLOCK JACK LABELING EXAMPLE.dwg

SECTION D

October 1, 2021