

# 7

## FEM Modeling: Mesh, Loads and BCs

## **Topics in Chapter 7**

**General Modeling Rules**

**Finite Element Mesh Layouts**

**Distributed Loads**

*NbN Lumping*

*EbE Lumping*

**Displacement BCs**

*suppressing rigid body motions*

*taking advantage of symmetry and antisymmetry*

## General FEM Modeling Rules

- Use the simplest elements that will do the job
- *Never, never, never* use complicated or special elements unless you are absolutely sure of what you are doing
- Use the coarsest mesh that will capture the dominant behavior of the physical model, particularly in *design* situations

3 word summary: ***Keep It Simple***

## **Another Justification for Simplicity**

**In product design situations  
several FEM models of increasing refinement  
will be set up as design evolves**

**Ergo, do not overkill at the beginning**

## Where Finer Meshes Should be Used

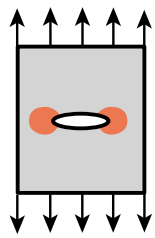

Cutouts

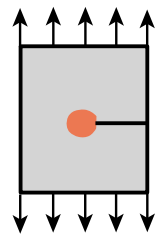

Cracks

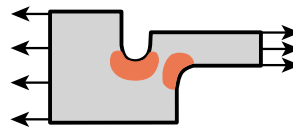

entrant corners

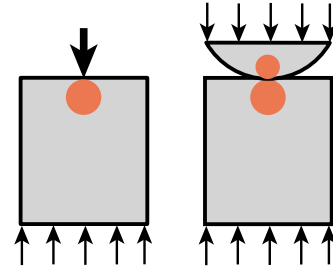

Vicinity of concentrated (point) loads, and sharp contact areas

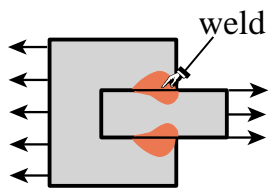

Load transfer  
(bonded joints,  
welds, anchors,  
reinforcing bars, etc.)

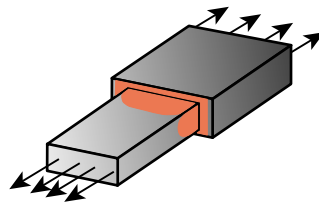

Abrupt thickness  
changes

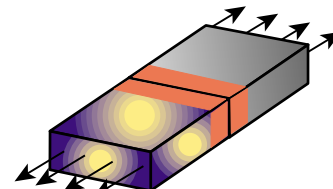

Material  
interfaces

## Avoid 2D/3D Elements of Bad Aspect Ratio

Good

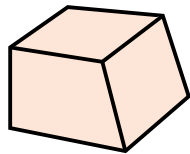
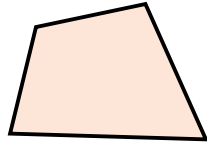
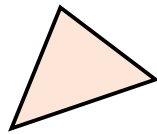

Bad

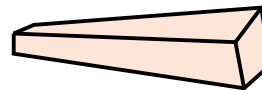
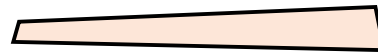
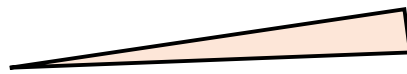

## Elements Must Not Cross Interfaces

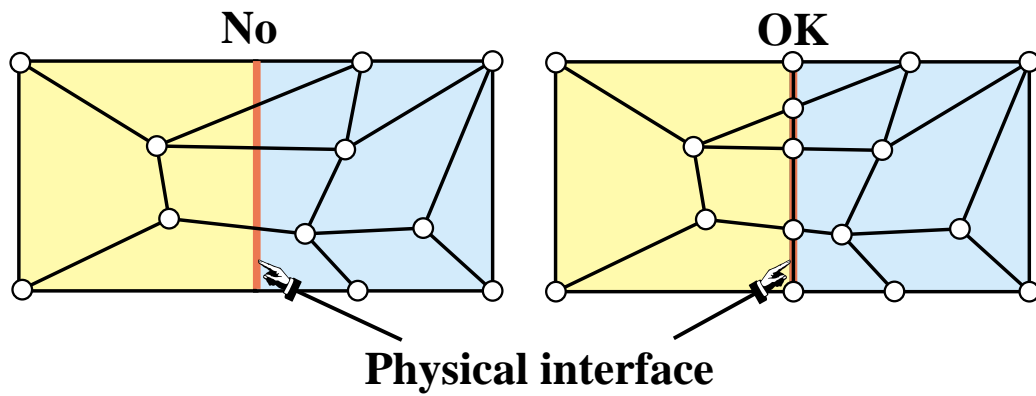

## **Element Geometry Preferences**

**Other things being equal, prefer**

**in 2D: Quadrilaterals over Triangles**

**in 3D: Bricks over Wedges  
Wedges over Tetrahedra**

(Elements do not file discrimination suits)

## Node by Node (NbN) Distributed Load Lumping

Nodal force  $f_3$  at 3 is set to  $P$ , the magnitude of the crosshatched area under the load curve. This area extends halfway over adjacent element sides

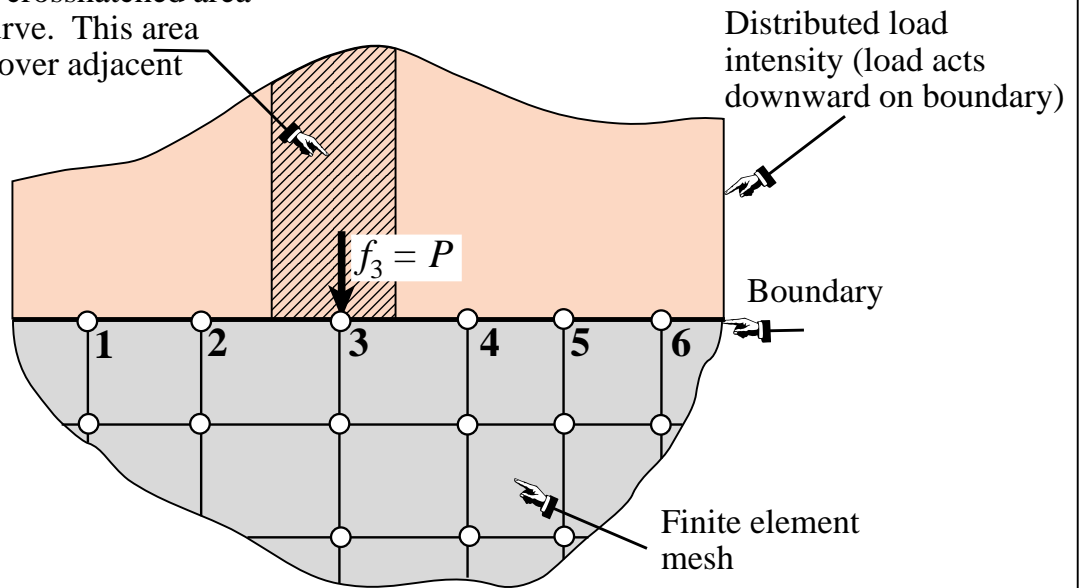

# Element by Element (EbE) Distributed Load Lumping

Force  $P$  has magnitude of crosshatched area under load curve and acts at its centroid

Distributed load intensity (load acts downward on boundary)

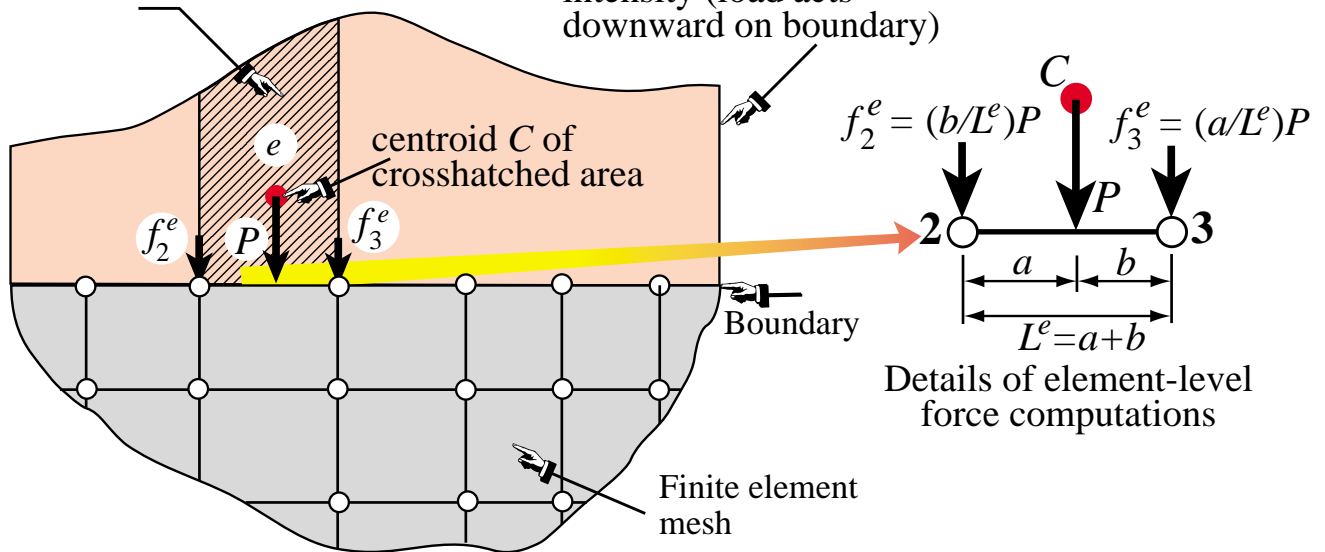

## EbE Shortcut for Linearly Varying Line Load (Bypasses Centroid Calculation)

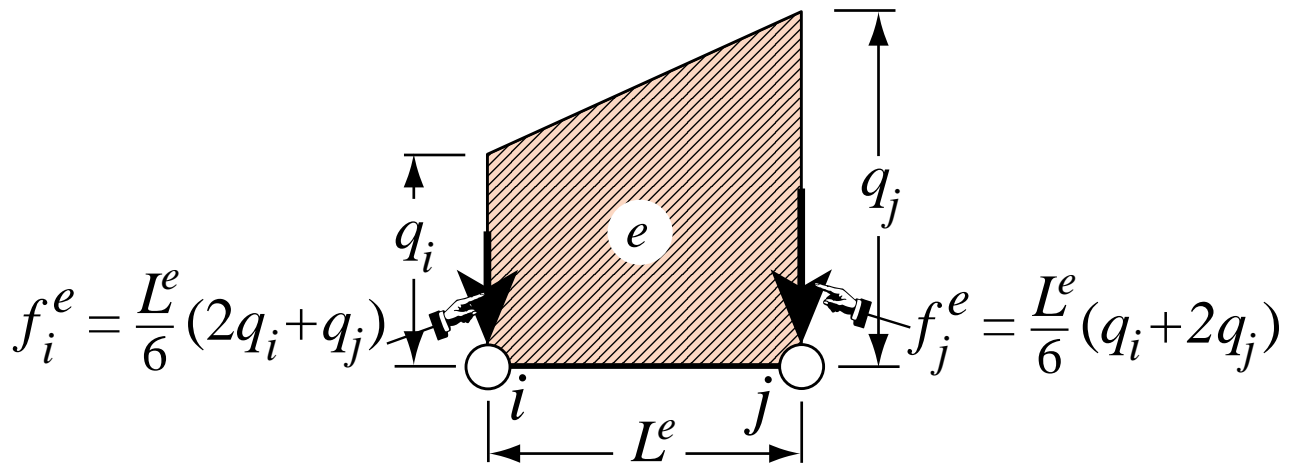

## **Boundary Conditions (BCs)**

**The most difficult topic for FEM  
program users**

**Two types** { **Essential**  
**Natural**

## Boundary Conditions Essential vs. Natural

### Recipe:

1. If a BC involves one or more DOF in a *direct way*, it is *essential* and goes to the **Left Hand Side (LHS)** of  $Ku = f$
2. Otherwise it is *natural* and goes to the **Right Hand Side (RHS)** of  $Ku = f$

## Minimum Support Conditions to Suppress Rigid Body Motions in 2D

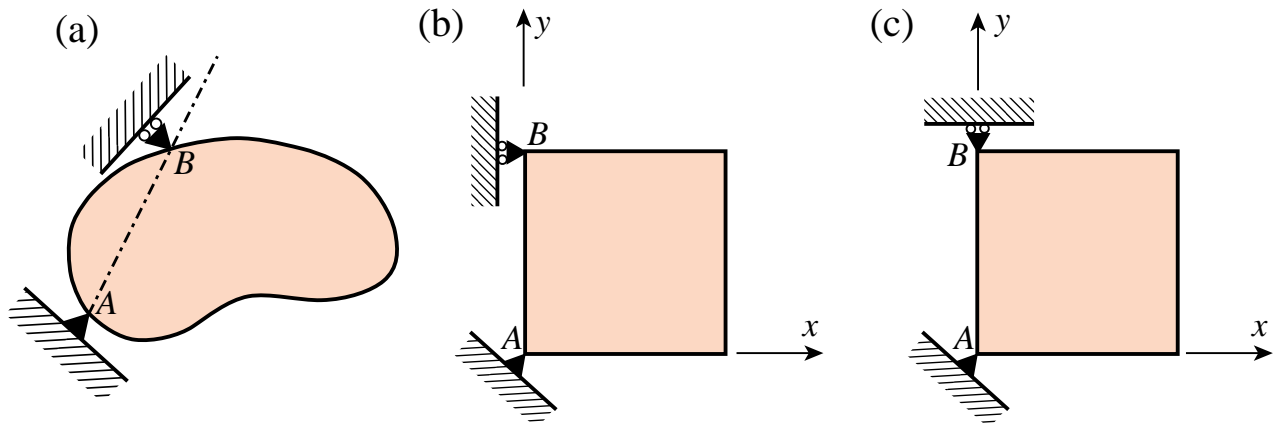

## Minimum Support Conditions to Suppress Rigid Body Motions in 3D

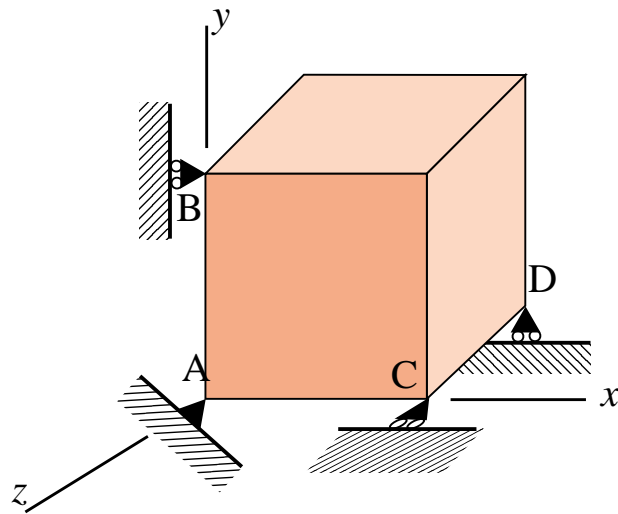

## Visualizing Symmetry and Antisymmetry Conditions in 2D

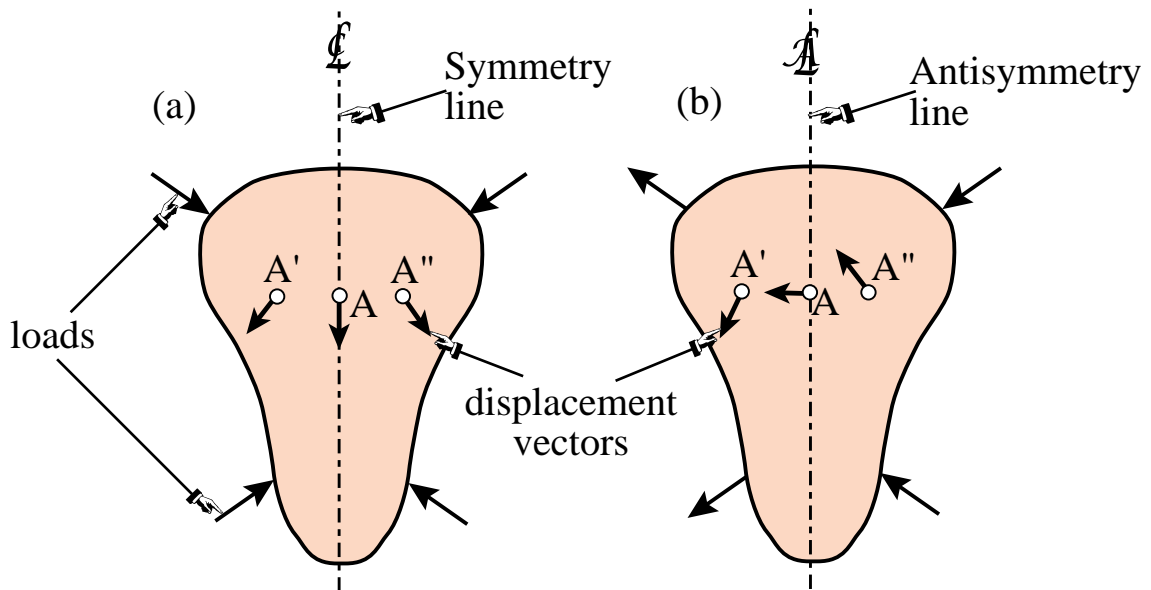

## Example of Application of Symmetry BCs

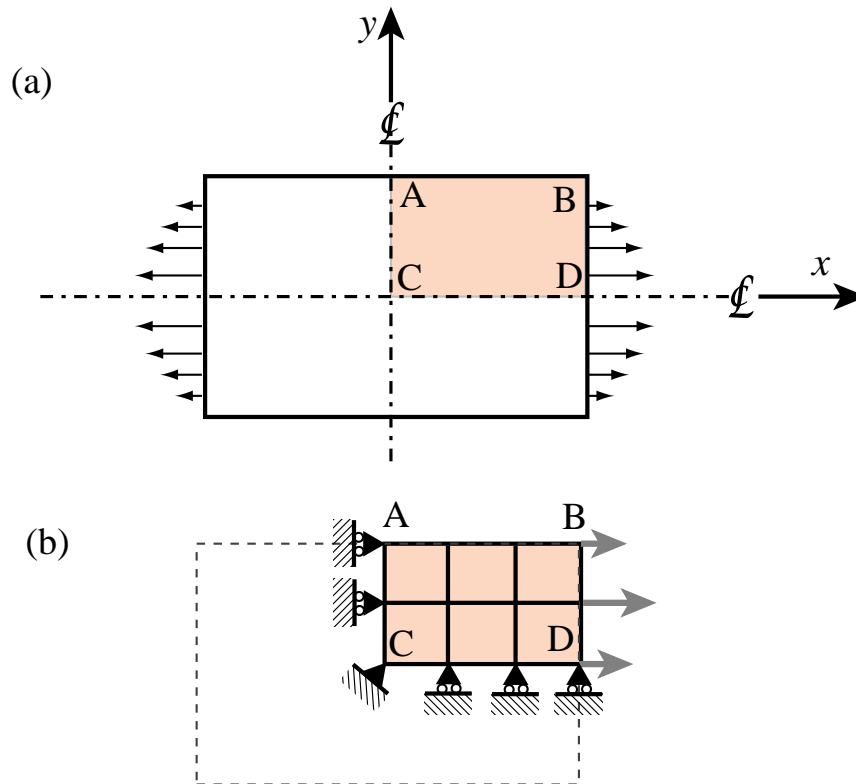

## Example of Application of Antisymmetry BCs

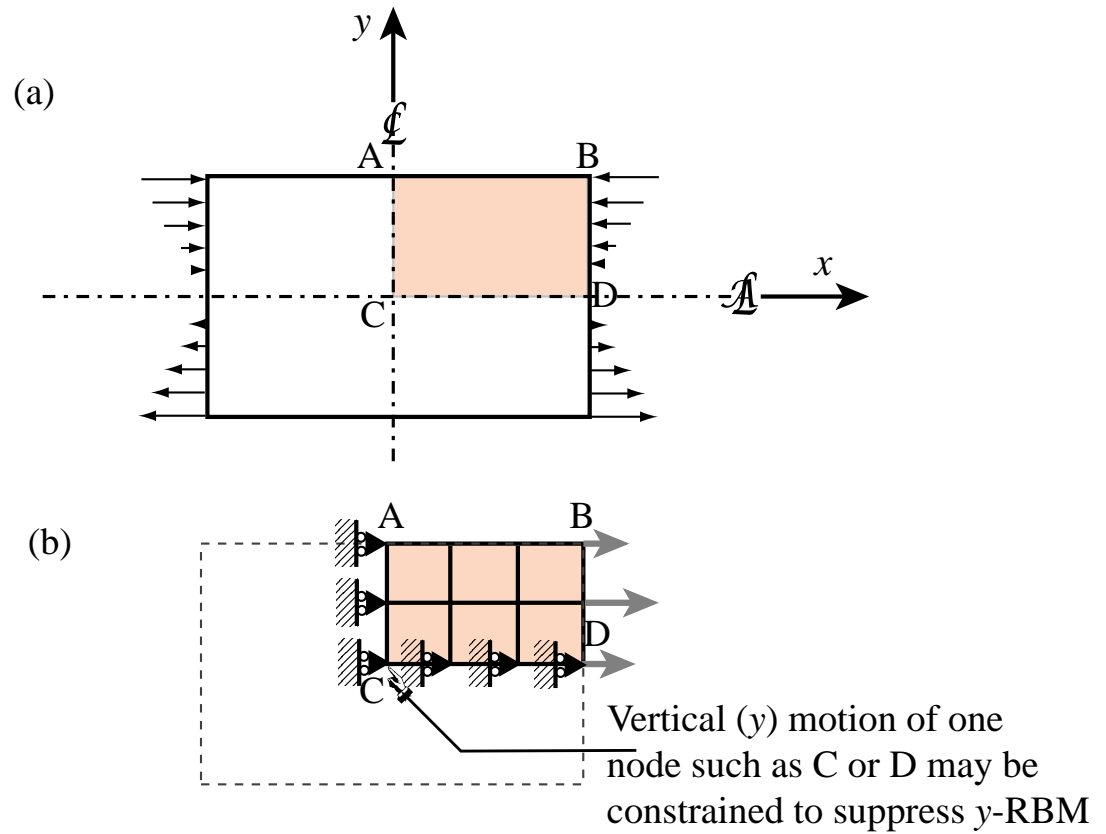

# "Breaking Up" Point Loads at Symmetry BCs

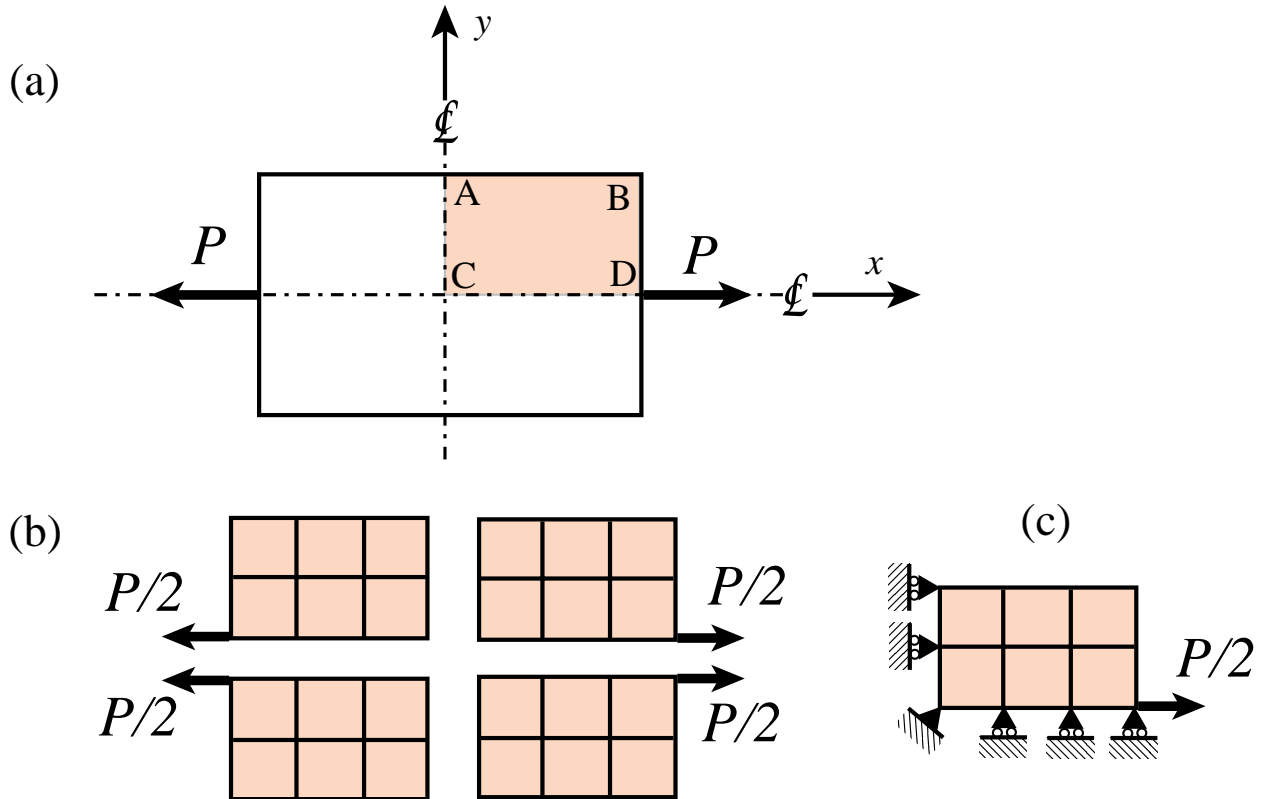

# "Breaking Up" Point Loads at Antisymmetry BCs

